

HOW TO PLAY

NES-7S-USA

SKI OR DIE™



T

ULTRA®

ULTRA SOFTWARE CORPORATION LIMITED WARRANTY

Ultra Software Corporation warrants to the original purchaser of this Ultra software product that the medium on which this computer program is recorded is free from defects in materials and workmanship for a period of ninety (90) days from the date of purchase. This Ultra software program is sold "as is" without express or implied warranty of any kind, and Ultra is not liable for any losses or damages of any kind resulting from use of this program. Ultra agrees for a period of ninety (90) days to either repair or replace, at its option, free of charge, any Ultra software product, postage paid, with proof of date of purchase, at its Factory Service Center.

This warranty is not applicable to normal wear and tear. This warranty shall not be applicable and shall be void if the defect in the Ultra software product has arisen through abuse, unreasonable use, mistreatment or neglect. THIS WARRANTY IS IN LIEU OF ALL OTHER WARRANTIES AND NO OTHER REPRESENTATIONS OR CLAIMS OF ANY NATURE SHALL BE BINDING ON OR OBLIGATE ULTRA. ANY IMPLIED WARRANTIES APPLICABLE TO THIS SOFTWARE PRODUCT, INCLUDING WARRANTIES OF MERCHANTABILITY AND FITNESS FOR A PARTICULAR PURPOSE, ARE LIMITED TO THE NINETY (90) DAY PERIOD DESCRIBED ABOVE. IN NO EVENT WILL ULTRA BE LIABLE FOR ANY SPECIAL, INCIDENTAL, OR CONSEQUENTIAL DAMAGES RESULTING FROM POSSESSION, USE OR MALFUNCTION OF THIS ULTRA SOFTWARE PRODUCT.

Some states do not allow limitations as to how long an implied warranty lasts and/or exclusions or limitations or incidental or consequential damages so the above limitations and/or exclusions of liability may not apply to you. This warranty gives you specific rights, and you may also have other rights which vary from state to state.

This game is licensed by Nintendo® for play on the

Nintendo
ENTERTAINMENT
SYSTEM®

Nintendo® and Nintendo Entertainment System® are registered trademarks of Nintendo of America Inc.



This official seal is your assurance that Nintendo® has reviewed this product and that it has met our standards for excellence in workmanship, reliability and entertainment value. Always look for this seal when buying games and accessories to ensure complete compatibility with your Nintendo Entertainment System®.

Ultra Software Corporation,
900 Deerfield Parkway,
Buffalo Grove, IL 60089-4510,
(708) 215-5111

WELCOME TO THE WORLD OF ULTRA!

You're now the proud owner of ULTRA's authentic version of Ski or Die for the Nintendo Entertainment System.[®] We suggest that you read the following instructions thoroughly before hitting the slopes in Rodney's Wacky Winter Wonderland.

TABLE OF CONTENTS

INTRODUCTION/HOW TO BEGIN	4
RODNEY'S SKI SHOP	5
SKI SHOP SELECTIONS	6
RODNEY'S WINTER WONDERLAND	7
INNER TUBE THRASHING	8
SNOWBOARD HALF PIPING	10
ACRO AERIALS	12
DOWNHILL BLITZING	14
SNOWBALL BLASTING	15
TAKING CARE OF YOUR GAME	18



STALKING IN A WINTER WONDERLAND

Once again, Rodney's slushy ski shack is open for business. But Rod and his host of inhospitables refuse to let you enjoy the sub-zero ski fest. Because ferocious freaks of nature like chainsaw totin' bunnies, punk rock penguins and bodacious polar bears are anxiously waiting to knock your poles out from under you. From the Snowboard Half Pipe to the Snowball Blast, this arctic adventure will have you wishing you were back at the chalet exchanging fondue recipes with a thick-necked man named Gunther.

But bogus moguls are only half your headaches. Because Twisted Lester and his lucky lawn dart are looking to pop the wind out of your sails in the Inner Tube Thrash. And if you're cool enough to avoid getting Lester's point, you'll get a chance to impress the fickle judges in the Downhill Blitz and the Acro Aerials (sorry, no hog-calling competitions).

So start waxing those skis if you plan on seeing the light of summer again. Because you can either backflip, pike or helicopter your way into the World Record Book...or a body cast.

HOW TO START YOUR SLALOM

To begin your pre-slope prep, press the Start Button when the title screen appears. Once inside Rodney's ski shop, you can decide to either SIGN IN, GO PRACTICE, GO COMPETE or just check out the high scores. To select your option, use the Control Pad to move the "Ski or Die" cursor to one of the four categories, then press the A Button to lock in your decision.

If you just want to ski and sightsee, select GO PRACTICE. Players can take turns practicing any event they choose. When you're done practicing an event, hit the Select Button. When the screen changes use the Control Pad to choose "Yes" or "No." "Yes" returns you to the same event.

"No" allows you to select another event. Press the A Button to lock in your decision. If you're done with all your practicing, ski back into the ski shop. If you plan on competing, you must register first (see p. 6 for details) and then select GO COMPETE before swooshing to victory—or the agony of defeat. In the COMPETE Mode players go in the order they are registered.



RODNEY'S ROOST

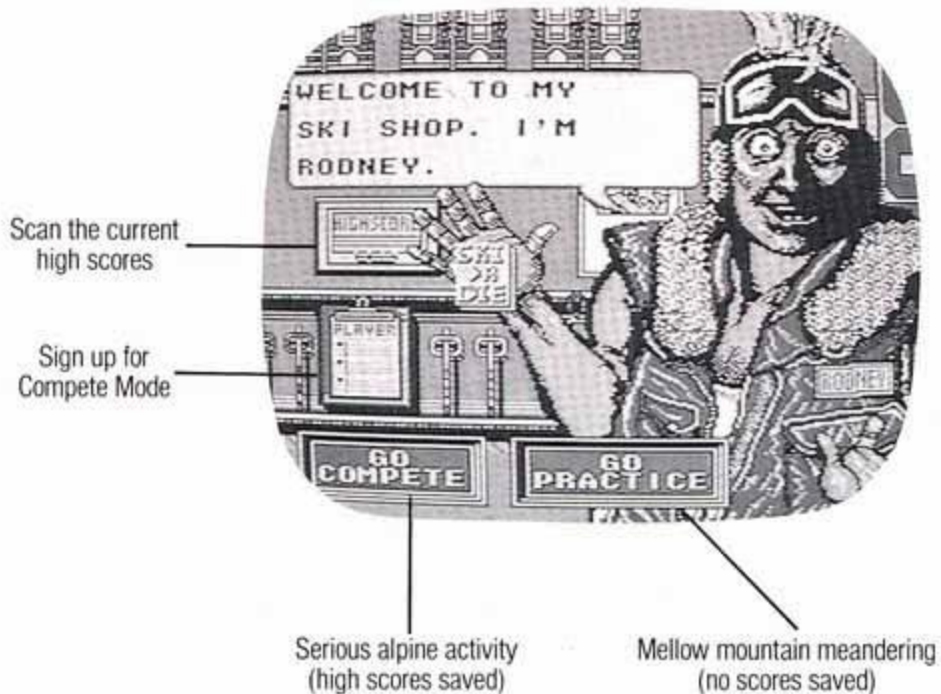

SKI SHOP SELECTIONS

Here is a closer look at some of your ski shop selections. Be advised to follow their directions if you don't want to end up in permanent hibernation. Move the cursor to "Player" and press the A Button. A clipboard will appear.

SIGNING-IN CEREMONIES



The Sign-In Screen for COMPETE Mode

Press the A Button to turn the tunes on or off. If you move the cursor down to END, then press the A Button, you will return to Rodney's ski shop. Next, move the cursor down to PLAYER 1 and press the A Button. This will bring the first player to the Name Registration Screen (see right) where the player's name can be entered. When PLAYER 1's name is entered, select END, then press the A Button to return to the Sign-In Screen. Next, press the A Button to register PLAYER 2. Continue this process until all players have registered. (Remember, up to 6 players can participate at any one time, with play alternating between players.)



Name Registration Screen

Use the Control Pad to select the letters of each player's name and press the A Button to lock in one letter at a time. If you make a mistake, press the B Button to delete the incorrect letter. If you want to delete an entire name, use the cursor to select CLR and press the A Button.

You must sign in each time you COMPETE in Ski or Die, because the names are deleted when the game is switched off.

NOTE: When a player's turn is up the next player can activate either Controller for game play by pressing the A or B Button when the prompt "Hit Button" appears. If you make a mistake, pause the game, use the Select Button to choose either Pause 1 (for Controller 1) or Pause 2 (for Controller 2). Then press the Start Button to activate the Controller.



High Score Screen

This illustrious snow screen will tell you who's melting the slopes with all the hottest moves. (Finish in the top three and your name and score will be posted on the score board.) Select by moving the cursor to the HIGH SCORE SCREEN, then press the A Button. Press either the A or B Button after you've checked out the bodacious points to return to Rodney's Ski Shop.

RODNEY'S WINTER WONDERLAND

Slush down this perilous path to compete in all five events. No slouches here.

Fire ice awaits all ski bums on this route to ruin.

Peak performance at 3,000 feet. Talk about high stakes.



Slick snowboards and fierce snowbunnies lurk down this lane.

Head-to-head zonking via infernal inflatables. Better put a bumper on your thumper!

The wild man's ski jump. Achieve double-digit hang time and gyrate your way to glory.

All competition courses extend out from the ski shop at the center. Move the skier standing in front of the ski shop to the desired course by pressing the Control Pad. Then press the A or B Button to ski. If you move the skier back to the ski shop the screen will return to Rodney.

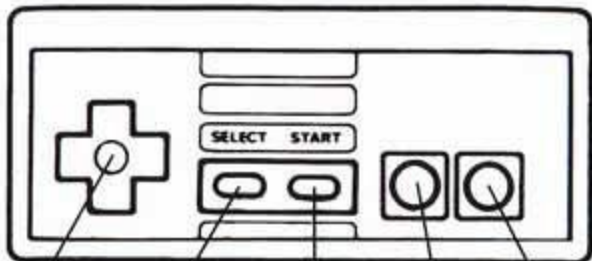

Control Pad Select Button Start Button B Button A Button

Control Pad Press Left or Right to change the skier's direction. Press Up along with the A or B Button and the skier will slow down. Press Down along with the A or B Button and the skier will speed up.

Select Button Press to end competition.

Start Button Press to pause the game. Press again to restart.

A and B Buttons To begin play, press the A Button at the start of every game stage. When an event is over, press either button and the Score Screen will appear. Press again to return to Rodney's Winter Wonderland.

BEAT ALL IN THE COMPETE ALL

Better keep your cool as you fly through a mammoth marathon of 5 events, one after another. Points are awarded for each event—5 points for top dog, 3 points for 2nd place, 1 for 3rd place and 0 for any stragglers. Added together, these make up your **OVERALL** (cumulative) score for the competition. The points you actually score in the event will appear next to your name under **SCORE**.

The Inner Tube Thrash is the last competition event. When you've completed it, check out the scores to see who won the overall competition.

NOTE: You cannot select **COMPETE ALL** if you're in the **PRACTICE** Mode. Once again, to end the game, hit the Select Button and then the A Button, and you will go to the next event.

INNER TUBE THRASH

Seems that Lester (yep, your ol' punky pal from Skate or Die™) found some old truck inner tubes in a garbage dump last summer and brought them to the slopes. Now he wants you to hop in one and join him for a downhill joust! Half the battle is beating the other guy down the hill—for that you need a good, inflated inner tube. The other half is making it hard for the other guy to stay pumped up—for that you need a good, sharp object.



How to get more mileage out of your tube

Press the Control Pad Left or Right to make the skier move in either direction. Press the Control Pad Left or Right while pressing the A Button and the skier will rotate in the desired direction. To speed up your skier, press Down on the Control Pad. To cut down on his MPH's, press Up on the Control Pad. And the moment you've all been waiting for: press the B Button to attack!

There are bonus points for the taking—300 for you if you burst your opponent's tube, and 200 for your opponent if you fall into a valley.

So, now that you're well-schooled in tube techniques, get ready to face your opponent and inflict a little grief and misery. Yeah!

IT'S EASY TO BURST SOMEONE'S BUBBLE WITH ONE OF THESE

To pick up a poker, simply run over it with your inner tube.



Dinner Fork OK—but better for tamales.



Lawn Dart—Pretty good little popper, if I say so myself.



Ranger Scout Pocket Knife—It'll whittle you down to size.

PUMPS AND PATCHES GIVE YOU AIR, TRAPS TAKE IT AWAY

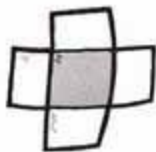

Patch—The quicker fixer upper.



Pump—This will "pump ...you up!"

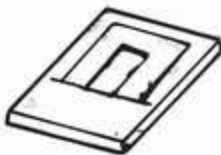

Mousetrap—Crazy Lester's calling card. If you fall in, it's 50 points for your opponent.



Beartrap—Avoid at all costs. If you don't, your opponent shovels in 100 points.

THE SCORE ON SCORING

Getting Help Pick up an object and gain valuable points—25 per weapon, 15 for a pump or patch.

Puncture Points Inflict damage with the dinnerware and receive 50 points. A hurt with the dart is worth a quick 125. And a mega 225 is yours for the taking with a pocket knife puncture.

Catch-Up A 100 point bonus for passing another player. (But don't look back to watch him eat your snow.)

First to Cross the Finish Line 1000 points. After all, that is the goal.

SNOWBOARD HALF PIPE

You've got 5 feet of snowboard, 48 inches of snow and it's 20 degrees below zero. So why not take a couple of minutes to tear down this tube by displaying your airborne talents? Fire off tricks from the tube floor, off either lip, or from the occasional stray mogul. Big speed means big points (and even bigger bruises). Snag the punked-out penguins, but keep your distance from the bunnies packing the power tools—a fall will cost you 5 seconds.

Oh yeah, watch out for lunatic logs. Those babies can trip you up too, junior.

Eyeball the Indicator for a speed check.

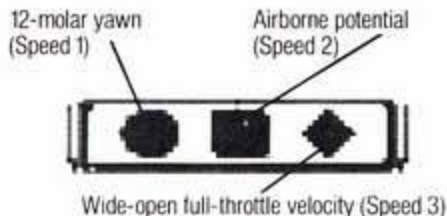

Increase speed and fly through the Rev Zones.



KEEP YOUR PEEPERS PEELED FOR THESE HALF PIPE HITCHERS



Punk Penguin
Worth 15 points.



Chainsaw Totin' Bunny
Worth a face transplant if you're not careful.



Ice Inflictor
Worth some serious snow burn.

A SUPER SLIDE RIDE, CLYDE

To glide peacefully along the Half Pipe, press the Control Pad Left or Right. If your skier is on an incline, his speed will increase, which will be indicated on the speed indicator.

THE MOVES YOU CAN MUSTER DEPENDS ON YOUR SPEED

Hold down the A Button and press in any of these directions.

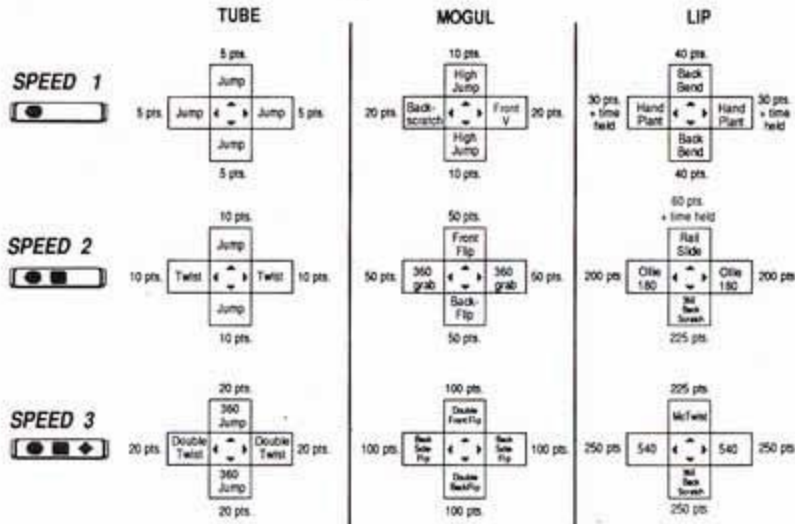

VARIETY REALLY ROCKS LESTER'S GIZZERIODS

The points indicated on the chart are only awarded the first time a move is performed. And because nobody wants to see the same move busted over and over, Lester's only gonna give you half points on the Half Pipe for repeat moves. But he'll also hand out a bonus at the end of the run, and if you want this bonus, you'd better do as many moves as inhumanly possible.

ACRO AERIALS

This ramp is built for speed. And if you've got the attitude, you'll get the altitude. Crank it up and hit the incline. The faster you go, the higher you jump—plus the more stunts you can perform. Simply stated: more ski, more fly! Press the A Button to start downhill. Pressing the Control Pad quickly Left and Right while simultaneously pressing either the A or B Button will motivate your skier to soar head and shoulders above the crowd (you hope).

Once you're airborne, move with a groove.

You'll need to hold down the A Button for most of these stunts, except for a couple. Timing is critical—if you let go of a Button in mid-stunt, you'll get a painful lesson in gravity.

NO BUTTON

Backflip: Pike
▲ ▼
Backflip: Layout

PRESS THE A BUTTON

Backflip: Tuck	Spread- Eagle	Moebius Flip
Daffy	◀ ▲ ▶ ▼	Split Jump
Double Backflip	Back- scratch	Moebius Flip

WOWING THE JUDGES

Five judges are waiting in the wings to grade your gonzo aerial dynamics. Each will give you anything from 0 (if you really take a big splat) to 10.0 (peak performance). Max score is 50 points per jump. Here's what the judges like to see:



DIFFICULTY The moves in grey (see diagram) take a lot of polishing. One or two per jump prove you're no pansy.

VARIETY Don't let the judges think you're a one trick pony. They want to see a variety of well-executed moves for a complete performance.

FLUIDITY It'll not only show how wet you are behind the ears, but also how cleanly you can move from twist to split to flip, etc. No stutters or pauses in transition...cool, dude?

POISE Just kidding. (We don't expect you to have any of that.) But remember, you get a total of three jumps when competing.

Reminder: Press the A Button after each jump.

THE DOWNHILL BLITZ WILL GIVE YOU FITS

Drop in, the powder's primo. Time and technique are everything here. Scream down the trails and airtime your way to mondo points. Crashes cost you time—take a detour into a tree, add 5 seconds. And don't be afraid to blaze a few trails for yourself—you never know what you might find. Stay on your skis the whole way (no wipe-outs), and you'll rack up an extra 1000 points.

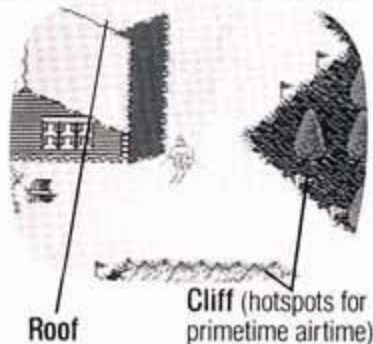

START THE CLOCK, ROCK

The main idea is to get downhill as fast as you can, but the more stomach-dropping stunts you perform along the way, the more points you shovel in. Press the A Button to start or restart the two-minute clock. Press the Control Pad Left or Right to move your skier in the desired direction. To speed up, press the Control Pad Down. To slow down, press the Control Pad Up.

NOTE: The above directions can be reversed by selecting the "Goofy" Mode with the B Button before play begins.

GET INTO SOME GYM-NASTIES

To jump, hold down the A Button and press the Control Pad in the desired direction. Try these stunts on for size:

Back Scratch—50 points

Daffy—50 points

Spread Eagle—75 points

360° Helicopter—100 points

If you finish in under two minutes, you'll get bonus points.

You'll also rake in bonus points for doing stunts while jumping over a snow hole.

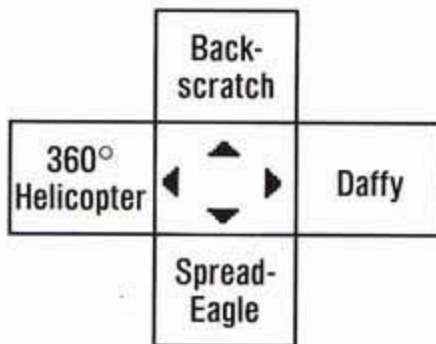

SNOWBALL BLAST

Rodney's looking to you to guard the munchies stash until after dinner. The only problem is a bunch of ice-packing Iglooheads want their snacks now. And they're coming in from all sides, so you'd better move in fast. It's a three level blast, so take out as many as possible before their snowballs frost your footsies.



Press the Control Pad to take aim. If you want to change directions, press the Control Pad while holding the A Button down. Finally, to launch your arctic arsenal of snowballs, press the B Button.

BLASTABLES (THE OPPOSITE OF LOVABLES)



Brats

Real close—25 points
Close—50 points
Farther—75 points
Way, way out—100 points

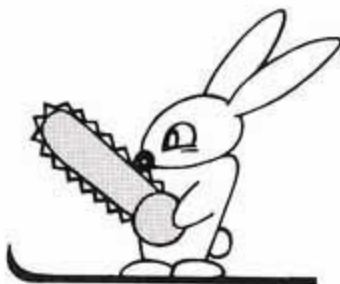

Chainsaw Bunnies

Could cost you an arm
and a leg—30 pts.



Iglooheads

No blubbering—30 pts.



Bodacious Bears

It's bearily possible—
30 pts.



Punk Penguins

Skin-a-tux—50 pts.



Abominable Snow Things

EEEEK!—'Nuff said—30 pts.

GET-ABLES (GRASP, DON'T BLAST)



Snowball Stash

Ammo gives you more whammo—100 additional snowballs, in fact.



Shovel

A must for digging out of avalanches. It also gives you some extra time.



Star

Gives you rapid-fire ability for a limited period of time without depleting your snowball supply. So fire at will.

UNTOUCHABLES



Ski Instructor

Always out-of-season. Lose twenty-five snowballs if you nail one, accidentally or otherwise.

It's a blast-fest in the COMPETE Mode.

Forget the formalities. In the COMPETE Mode you and your pals each get 60 seconds to take out 50 brats. Accomplish this mission and you'll slide into bonus blasting time. Good shooters: Add 1 point for each snowball left at the end of the event.

Treat Your ULTRAGAMES Cassette Carefully

- This ULTRAGAMES cassette is a precision-crafted device with complex electronic circuitry. Avoid subjecting it to undue shock or extremes in temperature. Never attempt to open or dismantle the cassette.
- Do not touch the terminal leads or allow them to come into contact with water or the game circuitry will be damaged.
- Always make sure your computer is SWITCHED OFF when inserting the cassette or removing it from the computer.



WARNING



DO NOT USE WITH FRONT OR REAR PROJECTION TV

Do not use a front or rear projection television with your Nintendo Entertainment System® ("NES") and NES games. Your projection television screen may be permanently damaged if video games with stationary scenes or patterns

are played on your projection television. Similar damage may occur if you place a video game on hold or pause. If you use your projection television with NES games, Nintendo will not be liable for any damage. This situation is not caused by a defect in the NES or NES games; other fixed or repetitive images may cause similar damage to a projection television. Please contact your TV manufacturer for further information.

COMPLIANCE WITH FCC REGULATIONS

This equipment generates and uses radio frequency energy and if not installed and used properly, that is, in strict accordance with the manufacturer's instructions, may cause interference to radio and television reception. It has been type tested and found to comply with the limits for a class B computing device in accordance with the specifications in Subpart J of Part 15 of FCC Rules, which are designed to provide reasonable protection against such interference in a residential installation. However, there is no guarantee that interference will not occur in a particular installation. If this equipment does cause interference to radio or television reception, which can be determined by turning the equipment off and on, the user is encouraged to try to correct the interference by one or more of the following measures:

- Reorient the receiving antenna
- Relocate the NES with respect to the receiver
- Move the NES away from the receiver
- Plug the NES into a different outlet so that computer and receiver are on different circuits.

If necessary, the user should consult the dealer or an experienced radio/television technician for additional suggestions. The user may find the following booklet prepared by the Federal Communications Commission helpful: How to Identify and Resolve Radio-TV Interference Problems. This booklet is available from the U.S. Government Printing Office, Washington, DC 20402. Stock No. 004-000-00345-4.

SCORES

ULTRA[®]
GAMES

Ski or Die™ and Skate or Die™ are trademarks of Electronic Arts. © 1990
Electronic Arts. All Rights Reserved.

Ultra® and ULTRAGAMES® are registered trademarks of Ultra Software Corporation.

© 1990 Ultra Software Corporation. All Rights Reserved.

Ultra Software Corporation, 900 Deerfield Parkway
Buffalo Grove, IL 60089-4510, (708) 215-5111